

ADA 086687

AFOSR TR-80-0531

18

19

12

9 Final Report, 1 Jul 79-31 Dec 81

LEVEL

6 Control of Vapor Emissions from Hydrazine-Based Fuels

(AFOSR-GRANT NO. 79-0034)

15 AFOSR-79-0434

16 2347

prepared by

17 D9

10

Dr. Gordon A. Lewandowski, P. E.

3 Department of Chemical Engineering

1 New Jersey Institute of Technology

323 High Street

2 Newark, NJ 07102

DTIC ELECTED JUL 14 1980

411840

11 30 Jun 80

12 53

Approved for public release; distribution unlimited.

LE COPY

411 840  
80 7 14 015 nit

REPORT DOCUMENTATION PAGE		READ INSTRUCTIONS BEFORE COMPLETING FORM
1. REPORT NUMBER <b>AFOSR-TR- 80-0531</b>	2. GOVT ACCESSION NO. <b>AD-A086687</b>	3. RECIPIENT'S CATALOG NUMBER
4. TITLE (and Subtitle)  <b>CONTROL OF VAPOR EMISSIONS FROM HYDRAZINE-BASED FUELS</b>	5. TYPE OF REPORT & PERIOD COVERED <b>FINAL</b> <b>1 July 1979 - 30 June 1980</b>	
	6. PERFORMING ORG. REPORT NUMBER	
7. AUTHOR(s)  <b>DR GORDON A LEWANDOWSKI</b>	8. CONTRACT OR GRANT NUMBER(s)  <b>AFOSR 79-0084</b>	
9. PERFORMING ORGANIZATION NAME AND ADDRESS <b>NEW JERSEY INSTITUTE OF TECHNOLOGY</b> <b>323 HIGH STREET</b> <b>NEWARK, NJ 07102</b>	10. PROGRAM ELEMENT, PROJECT, TASK AREA & WORK UNIT NUMBERS  <b>2307/D9</b> <b>61102F</b>	
11. CONTROLLING OFFICE NAME AND ADDRESS  <b>AFOSR/NA</b> <b>BUILDING 410</b> <b>ROLLING AFB, DC 20332</b>	12. REPORT DATE <b>June 30, 1980</b>	
	13. NUMBER OF PAGES <b>53</b>	
14. MONITORING AGENCY NAME & ADDRESS (if different from Controlling Office)	15. SECURITY CLASS. (of this report)  <b>UNCLASSIFIED</b>	
	15a. DECLASSIFICATION/DOWNGRADING SCHEDULE	
16. DISTRIBUTION STATEMENT (of this Report)  <b>Approved for public release; distribution unlimited.</b>		
17. DISTRIBUTION STATEMENT (of the abstract entered in Block 20, if different from Report)		
18. SUPPLEMENTARY NOTES		
19. KEY WORDS (Continue on reverse side if necessary and identify by block number)  <b>AIR POLLUTION CONTROL</b> <b>CONTROL OF VAPOR EMISSIONS</b> <b>HYDRAZINE</b> <b>HYDRAZINE FUELS</b>  <b>MMH</b> <b>MONOMETHYL HYDRAZINE</b>		
20. ABSTRACT (Continue on reverse side if necessary and identify by block number) <b>A theoretical study was made of four control devices as applied to vapor emissions of four hydrazine-based fuels. The fuels considered were: monomethyl hydrazine (MMH), hydrazine, H-70, and unsymmetrical dimethyl hydrazine (UDMH). The control techniques considered were: refrigeration, carbon adsorption, incineration, and scrubbing. Of these, refrigeration is not practicable, and too little is known about carbon adsorption to make a determination of its effectiveness. Design criteria were established for incinerators and scrubbers, and both were sized. A choice between the two must be made on an economic basis.</b>		

Accession For	
NTIS USA&I	<input checked="" type="checkbox"/>
DDC TAB	<input type="checkbox"/>
Unannounced Justification	<input type="checkbox"/>
By _____	
Distribution/ _____	
Availability Codes	
Dist	Available for special
A	

Qualified requestors may obtain additional copies from the Defense Technical Information Center; all others should apply to the National Technical Information Service.

Conditions of Reproduction

Reproduction, translation, publication, use and disposal in whole or in part by or for the United States Government is permitted.

AIR FORCE OFFICE OF SCIENTIFIC RESEARCH (AFSC)  
 NOTICE OF TRANSMITTAL TO DDC  
 This technical report has been reviewed and is approved for public release IAW AFR 190-12 (7b).  
 Distribution is unlimited.  
 A. D. BLOSE  
 Technical Information Officer

## Table of Contents

	<u>Page</u>
Summary.....	1
Introduction.....	2
Vapor Dispersion.....	4
Scrubbing.....	5
Incineration.....	11
Carbon Adsorption.....	13
Refrigeration.....	14
References.....	15
Table 1 - Maximum Permissible Vent Concentrations.....	16
Table 2 - Summary of Scrubber Operating Points.....	17
Table 3 - Required Refrigeration Coil Temperature.....	18
Figure 1 - Scrubber Schematic.....	19
Figure 2 - Packed Column Characteristics.....	20
Figure 3 - KSC Fuel Vapor Scrubbers.....	21
Appendix I - Calculation of Hydrazine/Water Vapor - Liquid Equilibrium.....	22
Appendix II - Calculation of MMH/Water Vapor-Liquid Equilibrium.....	25
Appendix III - Dispersion Calculations.....	27
Appendix IV - Refrigeration Calculations.....	30
Appendix V - Incineration Calculations.....	34
Appendix VI - Scrubber Calculations.....	38

## Summary

It was the purpose of this study to evaluate on a theoretical basis available emission controls for the following fuel vapors:

- a. monomethyl hydrazine (MMH)
- b. hydrazine
- c. unsymmetrical dimethyl hydrazine (UDMH)
- d. H-70 (70% hydrazine by wt., and 30% water)

Four control devices were evaluated:

- (1) scrubbing
- (2) incineration
- (3) carbon adsorption
- (4) refrigeration

Where possible, equilibrium calculations were made and design criteria established for these devices. The first two are technically practicable, while refrigeration can only be used as a control technique for H-70 vapors. Not enough is known about carbon adsorption to determine if it is a feasible technique or not. A choice between the first two devices would be made on a cost basis, and the information in this report should be sufficient to enable the solicitation of vendor quotations.

The major findings of this report were presented in a seminar given on January 9, 1980 at the Environics Directorate (AFESC), Tyndall AFB, Florida.

## Introduction

Hydrazine and derivative fuels (H-70, MMH, and UDMH) are used by the Air Force primarily as rocket propellants, and in aircraft emergency power units. As such, they must be transported, handled, and stored.

During all of these operations, emission of fuel vapors into the atmosphere or work environment will occur. These vapors are toxic in their own right, and potential carcinogens. Both the American Institute of Government and Industrial Hygienists (ACGIH) and the Occupational Safety and Health Administration (OSHA), have proposed reducing the 8 hr atmospheric exposure limit for hydrazine vapors from 1 vppm to 0.1 vppm (volume parts per million). The National Institute for Occupational Safety and Health (NIOSH) has recommended<sup>(10)</sup> still further limiting the occupational exposure for hydrazine to .03 vppm (.04 mg hydrazine/m<sup>4</sup> air). Recommended NIOSH limitations<sup>(10)</sup> for MMH and UDMH are .08 and .15 mg/m<sup>3</sup> respectively. Such low concentrations would require emission controls on fuel storage vents, and other potential release points.

Hydrazine-based fuels are stored in bulk quantities at Vandenberg AFB, Edwards AFB, Cape Kennedy (KSC), and Rocky Mountain Arsenal. Fuel vapors may be released from storage facilities, and truck loading operations; as well as during nitrogen venting of missile fuel lines, aircraft power units, and the space shuttle fuel pods. At the present time, these releases are generally uncontrolled, although KSC has recently installed hypergolic vapor scrubbers for some of their fuel handling operations.

The KSC scrubbers were designed by Martin Marietta<sup>(11)</sup>. The vapor flow rates and vent height associated with these scrubbers were used as the basis for the design cases studied in this report:

- vapor flow rates from 10 to 400 cfm (0.28 to 11.3 m<sup>3</sup>/min)
- fuel vapor temperatures up to 100°F (37.8°C) corresponding to equilibrium vapor concentrations up to 128,400 ppm (depending upon the type of fuel considered)
- vent diameter of 6 inches (15 cm), with a discharge height of 36 ft (11 m)

Following general industry practice in this area, the primary units used are American Engineering units.

### Vapor Dispersion

The proposed NIOSH limitations on hydrazine-fuel vapors<sup>(10)</sup> were used as the basis of the calculations in this report. Those limitations apply to the ambient concentrations, not the emission rate. Therefore, an elevated vent will also act as a "control" device by dispersing the hydrazine vapors and diluting them at ground level. The required efficiency, then, of any real control device depends to a significant extent on the height and diameter of the vent stack to which the control device discharges.

Table 1 lists the maximum allowable fuel concentrations from the control device, for vent heights of 36, 72, and 100 ft (11, 22, and 30.5 m), and for vent diameters of 1½" and 6" (4 and 15 cm). The calculation method is given in Appendix III.

Table 1 shows that for a ground level concentration of MMH of .04 ppm (0.09 mg/m<sup>3</sup>, as proposed by NIOSH) the concentration in a 36 ft., 6" diameter vent need only be reduced to 196 ppm. The latter concentration then becomes the discharge criterion for any control device.

For the purposes of this report, all control devices were designed for the most conservative case shown (i.e. for a 36 ft., 6" diameter vent).



## Scrubbing

Appendix VI contains the scrubber calculations for the following case:

MMH vapors at 49,140 ppm and 68°F (equilibrium condition), at flow rates ranging from 10 to 400 cfm (0.28 to 11.3 m<sup>3</sup>/min), with a 6" diameter, 36 ft. high exhaust vent.

This corresponds to a condition of high inlet concentration for the K5C scrubbers at the Hypergolic Maintenance Facility.

For this condition, an appropriate packed column design involves a 4 column system (see Figure 1):

- 2 in series to handle vapor flows from 72 to 400 cfm (2.0 to 11.3 m<sup>3</sup>/min), each 18" diameter (0.46m) x 8.8 ft (2.69m) high (with 20% safety factor), packed with 1" ceramic Intalox Saddles. Water flow rate is 8.8 gpm (.033 m<sup>3</sup>/min).
- 2 more columns in parallel to handle vapor flows from 10 to 72 cfm (0.28 to 2.0 m<sup>3</sup>/min), each 8" diameter (0.20m) x 5.3 ft. (1.62m) high (with 20% safety factor), packed with ½" ceramic Intalox Saddles. Water flow rate is 1.6 gpm (.006 m<sup>3</sup>/min).
- Plain water is used as the counter-current scrubbing liquor.
- Demisters must be added to the top of each set of parallel columns (above the liquid inlet nozzles) to minimize entrainment of fine liquid droplets.

The most important assumption made in arriving at this design is the value of the mass transfer coefficient, and its dependence on packing size and liquid flow rate. Since no coeffi-

cients have ever been measured for hydrazine-fuel vapors, a value for the ammonia/water system was assumed as the basis for design calculations. The error in making this assumption could be significant.

With this design, the theoretical effluent concentration of MMH will be 196 ppm in the exhaust vent, which will disperse to a maximum ground-level concentration of  $0.08 \text{ mg/m}^3$  (the recommended NIOSH limit).

The waste water from these scrubbers will have a maximum MMH concentration of 1.3 mole %. This waste water can be sent to a holding tank, neutralized with sodium hypochlorite, and discharged with the other treated effluent from the Space Center. It is recommended that whenever possible the water be used once to minimize treatment costs. However, if recycle of the scrubber water is desired, the sodium chloride concentration (resulting from the sodium hypochlorite neutralization reaction) will be a limiting factor. As the sodium chloride concentration increases, corrosion of the metal surfaces in the scrubber system will also increase. The best way to avoid this problem would be to install a deionizing column in the water recycle loop.

Scrubbing with water has definite operational advantages over scrubbing with dilute hydrochloric acid, or sodium hypochlorite solution. The latter two liquors present serious materials problems (corrosion), with little or no advantage in scrubber efficiency. At the effluent concentration levels being considered, mechanical design of the scrubber (liquid and vapor distribution, entrainment, and approach to flooding) will have greater effect

on efficiency than any differences in vapor-liquid equilibrium between water and other scrubbing liquids. Mechanical design will probably determine the real limits of efficiency.

For different fuel vapor temperatures (i.e. different inlet concentrations), and different fuels, the same scrubbers can be used by simply adjusting the water flow rate (see Table 2). A lower temperature of 43°F (6.1°C) was chosen for the scrubbers to avoid freezing of the scrubber liquor (water).

For the UDMH/water system, appropriate vapor-liquid equilibrium data are not yet available. UDMH is more volatile than MMH, but also has a higher proposed ambient limit (see Table 1). As a result, UDMH scrubbers would be expected to operate at about the same conditions as the MMH scrubbers.

Determination of which set of scrubber to use could be done manually, or automatically using a vapor flow sensor/controller. At 400 cfm, the gas pressure drop across the packed sections of the larger (18") scrubbers will vary from 8 to 14 inches of water (2.0 to 3.5 kPa, depending upon the water flow rate). As gas flow decreases to 72 cfm, the pressure drop will decrease to about 0.5 inches of water (0.125 kPa). For gas flows below 72 cfm, the inlet valve in the vapor line to the smaller (8") set of scrubbers will have to be opened, while the inlet valve to the 18" scrubbers are closed (see Figure 2). When 72 cfm of gas are flowing through the 8" scrubbers, the system will experience its maximum pressure drop of 10 to 30 inches of water (2.5 to 7.5 kPa). The purge gas pressure will have to be slightly greater than this in order to

force the gas through the system and out the stack. As the gas flow rate decreases to 10 cfm, the pressure drop across the 8" columns will decrease to about 0.5 in. water.

It should be noted that the scrubber discharge concentration will be below the lower explosion limit for all of the fuels considered.

There is one operating point that could raise the pressure drop across the 8" column to as much as 3.6 psi (25 kPa). This operating point is for MMH vapors at 100°F, and 72 cfm gas flow, and is near the flooding point (see below). If such a condition arises during actual operation, the column may have to be manually adjusted (as to water flow rate, and gas flow distribution between the parallel set of columns) in order to reach design efficiency within the system pressure constraints.

The present fuel vapor scrubbers at KSC have the following design characteristics (see Figure 3):

- 2 columns in series, each 30" diameter (0.76m) x 4 ft (1.22m) high, packed with 3/4" ceramic Intalox Saddles (Note: columns of this diameter generally use packing of 1" to 1½" in size<sup>(8)</sup>).
- 14% citric acid solution is used as the counter-current scrubbing liquor, at a rate of about 95 gpm (0.36 m<sup>3</sup>/min).

At 400 cfm, with an inlet MMH concentration of 49,140 ppm at 68°F, theoretical equations result in an estimated outlet concentration of 0.03 ppm for these scrubbers. Outlet concentrations actually measured by Martin Marietta under similar conditions are

at least 3 ppm<sup>(11)</sup>. Several factors could account for this difference: entrainment, channeling (i.e. poor liquid/gas distribution), errors in the analytical technique used, and finally, the value of .03 is based on assuming a mass transfer coefficient from the ammonia/water system (MMH-water coefficients are presently unknown). However, both .03 and 3 ppm are much lower than the 196 ppm actually needed in the exhaust gas (because of plume dispersion). Therefore, for 400 cfm of vapor flow, the KSC scrubbers are actually oversized (even though they do not meet the original design criterion of 0.2 ppm MMH outlet concentration).

At 160 cfm of vapor flow, the KSC scrubber diameter is so large that the pressure drop through the columns falls well below .05 inches H<sub>2</sub>O/ft. column. Such a low pressure drop can create gas distribution problems (see Figure 2).

At gas flows below 93 cfm, the KSC columns should flood with liquid. That is, the liquid flow (95 gpm) is so high compared to the gas flow that the gas begins to channel up through the bed in the form of bubbles, while the liquid actually becomes the continuous phase. This effectively negates the mass transfer surface provided by the packing. Instead of transferring MMH across a thin film of liquid coating the packing surfaces, MMH is simply transferred across a bubble interface. The result is a drop in efficiency.

Considering the above, it is not surprising that efficiencies observed with gas simply bubbling through the surge tank (the so-called "inoperative" mode) were generally about the same as efficiencies observed through the scrubbers themselves<sup>(11)</sup>.

Furthermore, with 14% citric acid as the scrubbing liquor, the efficiency was indeed observed to decline below 150 cfm<sup>(11)</sup>. However, an anomalous result was observed with 5% NaOCl as the scrubbing liquor. The efficiency actually appeared to decline above 150 cfm. It is hoped that tests to be conducted at the Space Center by the Environics Directorate of AFESC will clarify this issue.

An additional problem with the present KSC scrubbers is disposal of the spent scrubbing liquor. It still contains MMH as the citrate salt. At present, this liquor is expected to be incinerated. However, it would be much more economical to incinerate the purge gas directly, rather than first scrubbing and then being forced to incinerate a liquid waste with a much higher heat capacity. If water were used as the scrubbing liquor, the spent liquor could be neutralized chemically with sodium hypochlorite, diluted, and discharged (the discharged liquor will only contain sodium chloride, with trace amounts of NaOCl).

### Incineration

Appendix V contains the calculations for direct flame incineration (at a temperature of 1200°C) for 10 to 400 cfm of fuel vapor. At 400 cfm, regardless of whether natural gas, propane, or isopropanol is used as the fuel, the incinerator should be about 4 ft. (1.22 m) diameter x 12 ft. (3.66 m) long in order to have sufficient residence time in the combustion zone. Fuel requirements are: 2400 ft<sup>3</sup>/hr (STP) of natural gas (68 Nm<sup>3</sup>/hr), or 904 ft<sup>3</sup>/hr (STP) of propane (25.6 Nm<sup>3</sup>/hr), or 0.464 gpm of isopropanol (.002m<sup>3</sup>/min).

These results are independent of whether MMH, UDMH, hydrazine, or H-70 are burned, and also independent of their vapor concentration. The only important variable is the vapor flow rate, to which the required incinerator volume and fuel rates are roughly proportional.

An alternative to direct flame incineration is catalytic incineration. In the latter process, a platinum or rhenium catalyst is used to oxidize the vent gases at lower temperatures (perhaps 500 to 800°C). The higher initial investment over direct flame incineration may be compensated for by a decrease in fuel requirements. Since the purge gas does not contain any components that would poison the catalyst (such as sulfur), catalyst life is expected to be long.

Since the amount of fuel vapor is very small, nitrogen oxides formed by the oxidation of the fuel will be of negligible importance. However, the remainder of the purge gas is nitrogen, which will form so-called "thermal NO<sub>x</sub>" under the conditions of direct flame incineration (the temperatures for catalytic oxidation are

too low to form thermal  $\text{NO}_x$ ). The State of Florida only has an ambient annual average limitation on nitrogen oxides (there are no  $\text{NO}_x$  emission limitations for incinerators). This is typical for most states. Since the incinerators will only be operated intermittently, on relatively small volumes of purge gas, the impact on ambient annual average  $\text{NO}_x$  concentrations is expected to be insignificant.

Since the combustion gases should be free of particulates and sulfates, some of the heat in these gases could be recovered by installing a waste heat boiler downstream of the incinerator. However, this will increase the capital investment, and only provide steam when the incinerator is operating, which is likely to be intermittent. Unless there is a local need for the intermittent supply of low pressure steam, a waste heat boiler would not be economical.



### Carbon Adsorption

Data taken by Thomas Stauffer of the Environics Directorate of AFESC indicate that hydrazine vapor will adsorb and possibly auto-oxidize on the surface of activated carbon. The process appears to have a high degree of efficiency, and this method may be quite promising. However, virtually no data of a design nature are yet available. Needed are the efficiency as a function of: carbon column height and diameter, vapor flow rate, and vapor concentration. If the mechanism is entirely or primarily adsorption, loading rates are also needed.

### Refrigeration

Appendix IV contains the procedures used for the refrigeration calculations.

This method of vapor control is the least promising. It cannot be used at all for hydrazine or UDMH vapor, because the required refrigeration coil temperature is below the condensate freezing point. Although the freezing point for MMH is 7°F lower than the required coil temperature, this difference is not sufficient to provide an adequate design point. The only fuel for which refrigeration is feasible is H-70. But even for this fuel, the value of the recovered H-70 is unlikely to be sufficient to justify the high cost of a refrigeration unit.

Table 3 contains a summary of the required coil temperatures and freezing points.

### References

1. Dodge, B. F., Chemical Engineering Thermodynamics, pp. 552-553 (1944).
2. Audrieth, L. F., & Ogg, B. A., The Chemistry of Hydrazine, pp. 106-107 (1951).
3. Marsh, W. R., and Knox, B. P. USAF Propellant Handbooks, Hydrazine Fuels, Volume 1, AFRPL-TR-69-149 (March, 1970).
4. Supportive data from E. Fochtman, Illinois Institute of Technology Research Institute (private communication).
5. Turner, D. B., Workbook of Atmospheric Dispersion Estimates, U. S. Public Health Service Pub. No. 999-AP-26 (1969).
6. Felder, R. M., & Rousseau, R. W., Elementary Principles of Chemical Processes, pp. 214, 314, 532 (1978).
7. Hitchcock, David A., "Solid-Waste Disposal: Incineration," Chemical Engineering, pp. 185-194 (May 21, 1979).
8. "Design Information for Packed Towers," Bulletin DC-11 (1977), the Norton Company, P. O. Box 350, Akron, Ohio 44309.
9. "Considerations in Design and Scale-up of Packed Beds," by John S. Eckert, the Norton Company, Akron, Ohio.
10. Criteria Document recommendations from the National Institute for Occupational Safety and Health (Rockville, Maryland).
11. Murdock, T. A., and Reisert, T. D., "Performance Test of Hypergolic Propellant Vapor Scrubbers," Martin Marietta Test Report T-77-37-4, (October, 1977).

Table 1

Maximum Permissible Vent Concentrations (MPVC)

Fuel	Proposed Ambient Limit (mg/m <sup>3</sup> )(10)	Vent Diameter (inches)	Vent Height(ft)	MPVC(ppm)
MMH	0.08 (.04ppm)	6	36	196
			72	392
			100	545
		1½	36	784
			72	1568
			100	2180
Hydrazine (or H-70)	0.04 (as hydrazine) (.03 ppm)	6	36	98
			72	196
			100	273
		1½	36	392
			72	784
			100	1032
UDMH	0.15 (.06 ppm)	6	36	368
			72	736
			100	1022
		1½	36	1472
			72	2944
			100	4088

Table 2

Summary of Scrubber Operating Points

- For:
- 4 columns, with counter-current water flow
  - 2 in series, to handle vapor flows from 72 to 400 cfm, each 18 in. diameter x 8.8 ft high, packed with 1" ceramic Intalox Saddles.
  - 2 more acting as a parallel set of series columns, to handle flows from 10 to 72 cfm, each 8 in. diameter x 5.3 ft high, packed with  $\frac{1}{2}$ " ceramic Intalox Saddles.

	T(°F)	Equilibrium ppm in	ppm out	Water Flow(gpm)	
				for Vapor Flow(cfm)	
				400	72
MMH	43	20,909	196	6.2	1.1
Hydrazine		5,736	98	4.2	0.87
H-70		2,689	98(as hydrazine)	2.3	0.48
MMH	68	49,140	196	8.8	1.6
Hydrazine		13,860	98	6.4	1.1
H-70		6,497	98(as hydrazine)	4.0	0.83
MMH	100	128,362	196	11.8	2.2
Hydrazine		38,947	98	9.3	1.7
H-70		18,142	98(as hydrazine)	6.3	1.1

Table 3Required Refrigeration Coil Temperature (RCT)  
(for 36 ft high, 6 in. diameter vent stack)

<u>Fuel</u>	<u>RCT(°F)</u>	<u>Fuel Freezing Pt. (°F)<sup>(3)</sup></u>
MME	-55.5	-62.3
Hydrazine	-53.3	+34.8
UDMH	-79.6	-70.9
H-70	-36.4*	-58.5**

\* for fuel originally at 68°F

\*\* for condensate with 55.4 mole % hydrazine

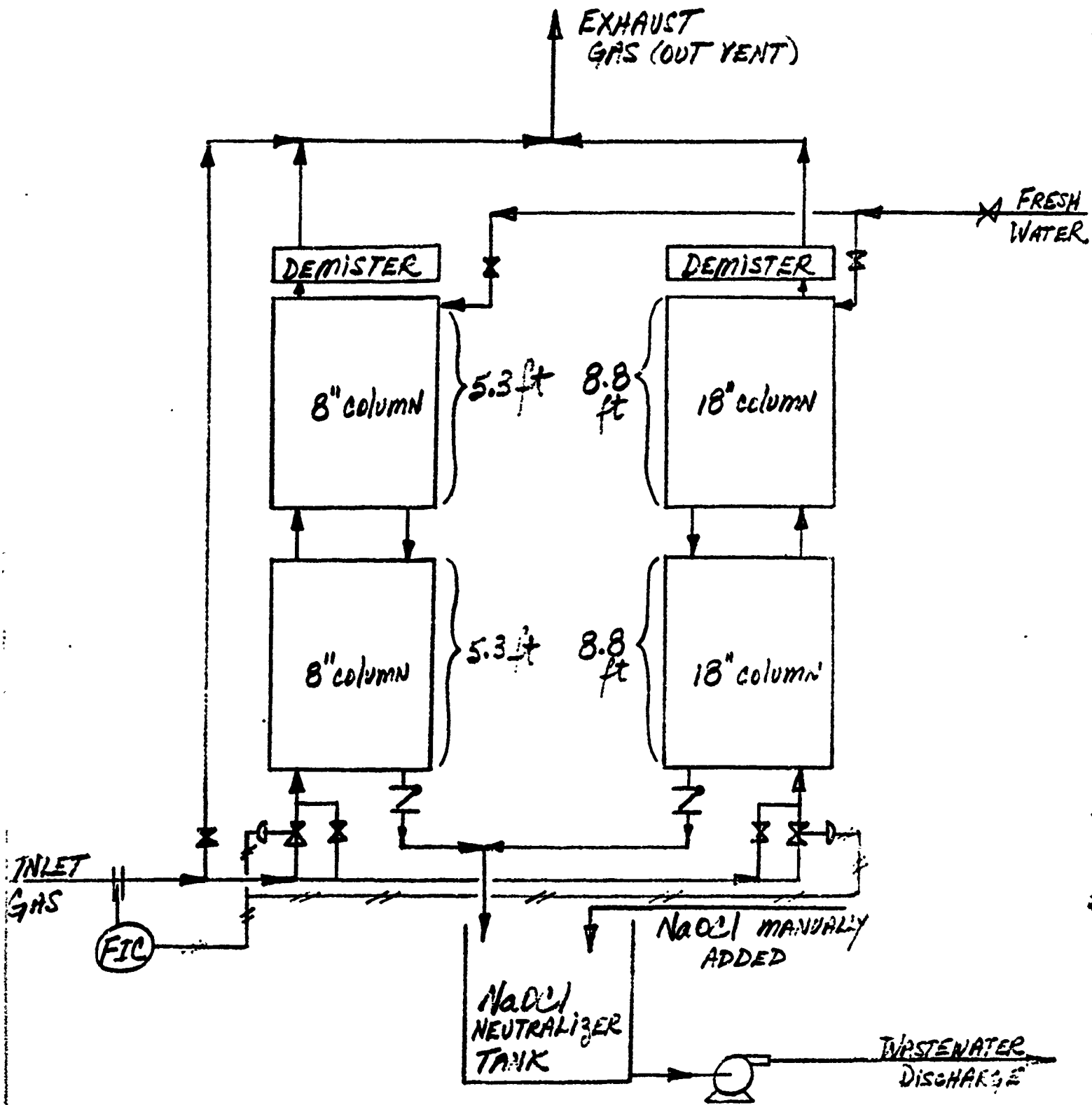
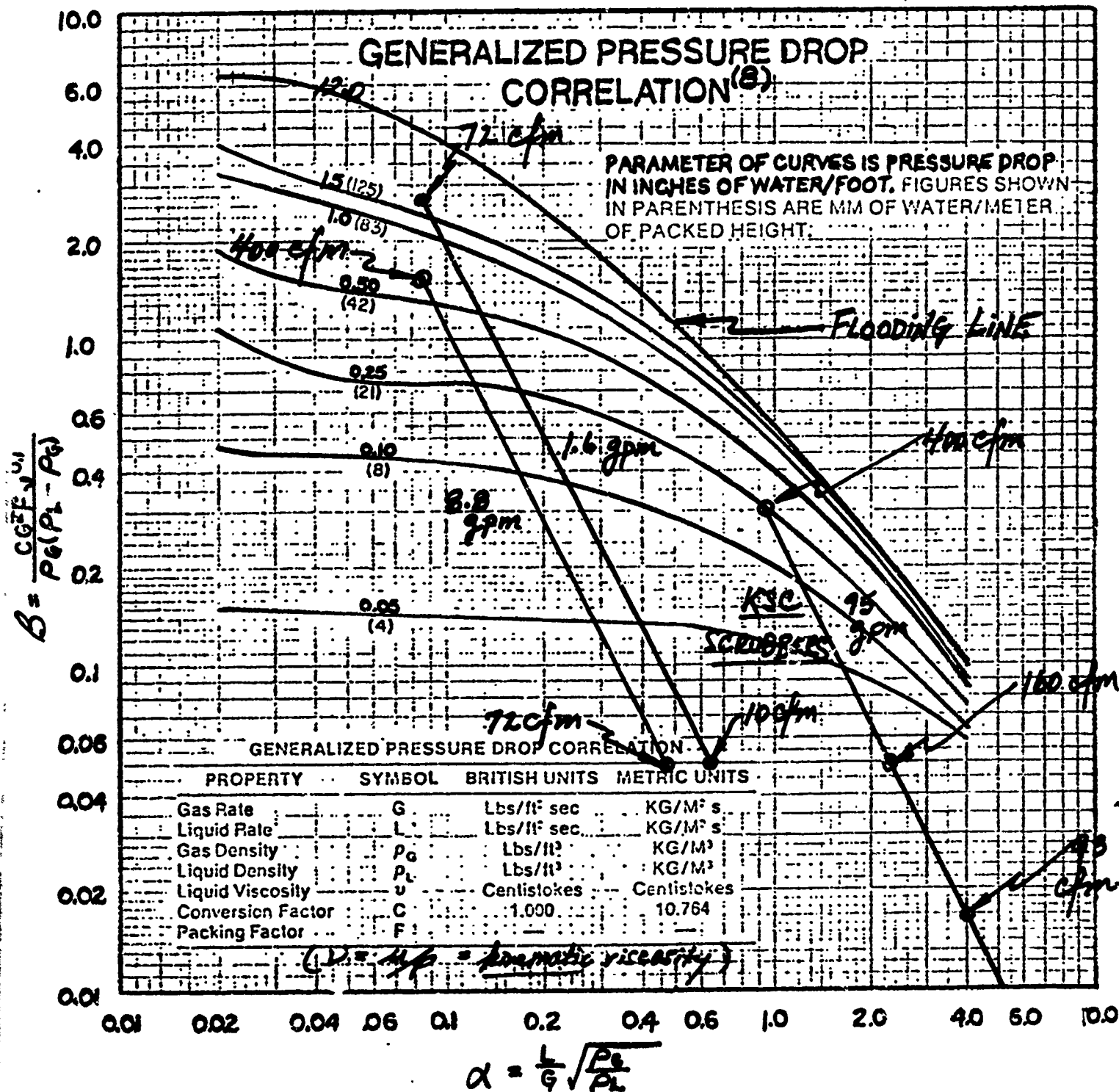

FIGURE 1 - PROPOSED SCRUBBER SCHEMATIC

**FIGURE 2 - PACKED COLUMN CHARACTERISTICS**



DATA OF STRIGLE, RUKOVENA AND HOLLISON

© 1978, Norton Chemical Process Products Division, Akron, Ohio 44328

2-751-31412-1276 Printed in U.S.A.

**NORTON** CHEMICAL PROCESS PRODUCTS DIVISION



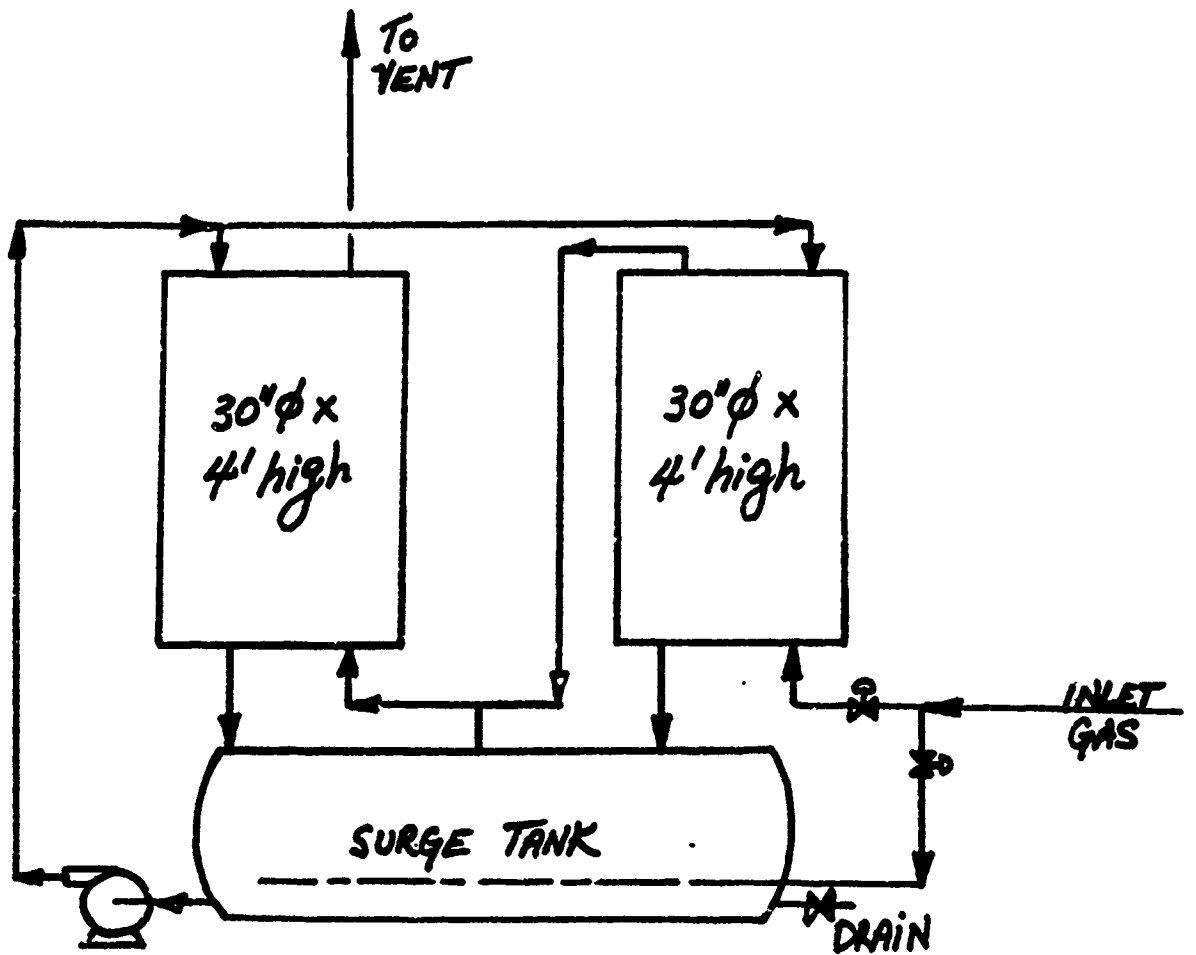

FIGURE 3 -  
KSC FUEL VAPOR SCRUBBERS

Appendix I

Calculation of Hydrazine/Water Vapor-Liquid Equilibrium

Vapor-liquid equilibrium data can be predicted from the azeotropic composition (e.g., see reference 1). For hydrazine/water, an azeotrope exists at 120.5°C (771 mm Hg), for a hydrazine content of 58.5 mole % <sup>(2)</sup>. This translates to the following equations for the activity coefficients:

$$\log_{10} \gamma_a = \frac{-1.0680}{\left[1 + \frac{1.0680X_a}{0.5410(1-X_a)}\right]^2}$$

$$\log_{10} \gamma_b = \frac{-0.5410}{\left[1 + \frac{0.5410(1-X_a)}{1.0680X_a}\right]^2}$$

where  $\gamma_a$  = activity coefficient of hydrazine

$\gamma_b$  = activity coefficient of water

$X_a$  = mole fraction of hydrazine in the liquid phase

the activity coefficients can then be used to predict the vapor composition, by knowing the temperature, pressure, and liquid composition:

$$Y_a = \frac{\gamma_a P_a^\circ X_a}{P}$$

$$Y_b = \frac{\gamma_b P_b^\circ (1-X_a)}{P}$$

where  $Y_a$  = mole fraction of hydrazine in the vapor phase

$Y_b$  = mole fraction of water in the vapor phase

$P$  = total system pressure (generally, 760 mm Hg)

$P_a^\circ$  = vapor pressure of hydrazine at the system temperature

$P_b^\circ$  = vapor pressure of water at the system temperature

Data correlations exist for  $P_a^\circ$  (reference 3), and  $P_b^\circ$  (reference 6):

$$\log_{10} P_a^\circ \text{ (mmHg)} = -6.50603 - \frac{653.880}{T} + 0.047914T - 4.9886 \times 10^{-5} T^2$$

(for  $T = 273$  to  $393^\circ\text{K}$ ; however, this equation was also used below  $273^\circ\text{K}$ )

$$\log_{10} P_b^\circ \text{ (mmHg)} = 8.10765 - \frac{1750.286}{235.0 + T}$$

(for  $T = 0$  to  $60^\circ\text{C}$ ; however, this equation was also used below  $0^\circ\text{C}$ : error at  $-15^\circ\text{C}$  is only 1.2%)

$$\log_{10} P_b^\circ \text{ (mmHg)} = 7.96681 - \frac{1668.21}{228.0 + T}, \text{ (for } T=60 \text{ to } 150^\circ\text{C)}$$

Table A-1 is a comparison between actual<sup>(2)</sup> and predicted values of the vapor composition of various hydrazine/water mixtures. The results in general are quite good (most of the predicted values fall within 8% of the actual value). However, when the hydrazine vapor composition drops below about 5 mole %, errors in the analytical method become relatively large, and these are believed to be the reason for the larger deviations between predicted and actual values of the vapor composition.

Table A-1  
 Comparison of Measured<sup>(2)</sup> and Predicted Values for  
 Hydrazine/water VLE

$x_a$	T(°C)	P(mm Hg)	$y_a$ (meas.)	$y_a$ (calc.)	% Dev.
.111	105	760	.014	.016	14.3
.119	106	"	.015	.019	26.7
.183	108	"	.040	.045	12.5
.195	107	756	.027	.052	92.6
.264	114	760	.100	.105	5.0
.317	116	"	.155	.162	4.5
.326	117	"	.168	.172	2.4
.332	117	"	.184	.180	2.2
.340	115	756	.138	.191	38.4
.367	119	760	.226	.227	.4
.417	118	756	.250	.304	21.6
.429	119	768	.303	.323	6.6
.450	120	760	.387	.358	-7.5
.452	119	768	.349	.361	3.4
.479	120	760	.419	.407	-2.9
.480	122	"	.425	.408	-4.0
.503	120	768	.417	.448	7.4
.518	120	771	.446	.473	6.1
.533	120	"	.488	.499	2.3
.548	120	"	.528	.524	-.8
.560	121	"	.530	.544	2.6
.658	120	"	.720	.696	-3.3
.683	120	"	.755	.730	-3.3
.727	120	"	.810	.785	-3.1
.736	119	"	.837	.796	-4.9

Appendix II

Calculation of MMH/Water Vapor-Liquid Equilibrium

As with hydrazine/water systems (see Appendix I), the vapor-liquid equilibrium data for MMH/water can be predicted from the azeotropic composition. However, azeotrope data is hard to find for the MMH/water system. It appears<sup>(5)</sup> that an azeotrope exists at 105°C (760 mmHg), for an MMH content of 25 mole %. This translates to the following equations for the activity coefficients:

$$\log_{10} \gamma_c = \frac{-0.9172}{\left[ 1 + \frac{0.9172X_c}{0.3273(1-X_c)} \right]^2}$$

$$\log_{10} \gamma_b = \frac{-0.3273}{\left[ 1 + \frac{0.3273(1-X_c)}{0.9172X_c} \right]^2}$$

where  $\gamma_c$  = activity coefficient of MMH

$\gamma_b$  = activity coefficient of water

$X_c$  = mole fraction of MMH in the liquid phase

The activity coefficients can then be used to predict the vapor composition, by knowing the temperature, pressure, and liquid composition:

$$Y_c = \frac{\gamma_c P_c^\circ X_c}{P}$$

$$Y_b = \frac{\gamma_b P_b^\circ (1-X_c)}{P}$$

where  $Y_c$  = mole fraction of MMH in the vapor phase

$Y_b$  = mole fraction of water in the vapor phase

$P$  = total system pressure (generally, 760 mmHg)

$P_c^\circ$  = vapor pressure of MMH at the system temperature

$P_b^\circ$  = vapor pressure of water at the system temperature

(see Appendix I)

From reference (3):

$$\log_{10} P_c^\circ \text{ (mmHg)} = 7.11158 - \frac{1104.571}{T} - \frac{152227.6}{T^2}$$

(for  $T = 273$  to  $363^\circ\text{K}$ ; however, this equation was also used below  $273^\circ\text{K}$ )

UDMH Vapor Pressure<sup>(3)</sup>

$$\log_{10} P_d^\circ \text{ (mmHg)} = 6.73578 - \frac{875.89}{T} - \frac{140001.0}{T^2}$$

(for  $T = 235$  to  $340^\circ\text{K}$ ; however, this equation was also used below  $235^\circ\text{K}$ )

Appendix III  
DISPERSION CALCULATIONS

As given in Reference 5, the applicable dispersion equations are as follows:

$$X = \frac{Q \times 10^6}{\pi \sigma_y \sigma_z U} \exp \left[ -\frac{1}{2} \left( \frac{H}{\sigma_z} \right)^2 \right]$$

$$H = h + \Delta H$$

$$\Delta H = \frac{1.65 V_s D}{U} \left[ 1 + 1.81 \frac{\Delta T}{T_s} D \right]$$

$$\Delta T = T_s - T_a$$

Where  $X$  = plume centerline, ground-level concentration (10 min. avg.) at wind speed  $U$  and downwind distance  $X$  ( $\mu\text{g}/\text{m}^3$ )

$Q$  = discharge rate of pollutant (g/sec)

$\sigma_y, \sigma_z$  = dispersion parameters, in meters (functions of downwind distance  $X$ ). For "C" (neutral, or slightly unstable) atmospheres:

$$\sigma_y = 0.20X^{.91}$$

$$\sigma_z = 0.11X^{.91}$$

$U$  = wind speed (m/sec)

$H$  = effective stack height (m)

$h$  = actual stack height (m)

$\Delta H$  = plume rise (m)

$V_s$  = stack discharge velocity (m/sec)

$D$  = stack discharge diameter (m)

$T_s$  = stack discharge temperature ( $^{\circ}\text{K}$ )

$T_a$  = average ambient temperature ( $^{\circ}\text{K}$ )

If this equation is differentiated with respect to  $U$ , and set equal to zero, an expression will be obtained for the wind speed ( $U_c$ ) that will result in a maximum ground-level concentration of pollutant.

Similarly, if it is differentiated with respect to  $X$ , and set equal to zero, an expression will be obtained for the downwind distance ( $X_c$ ) at which the ground-level concentration will be a maximum.

Substitution of  $U_c$  and  $X_c$  into the equation for  $\chi$  gives the ground-level concentration ( $\chi_c$ ) which is maximized both with respect to wind speed and downwind distance. It is, therefore, the highest ground-level concentration theoretically possible:

$$\chi_c = \frac{1.95 \times 10^4 Q}{h v_s D \left[ 1 + 1.81 \frac{\Delta T}{T_s} D \right]}$$

At Kennedy Space Center:

$$h = 36 \text{ ft. (minimum)} = 10.97 \text{ meters}$$

$$D = 6 \text{ inches} = 0.1524 \text{ meters}$$

$$T_s \approx T_a, \quad \therefore \Delta T = 0$$

At a fuel vapor rate of 10 cfm:

$$v_s = \frac{10 \text{ ft}^3/\text{min}}{\frac{\pi}{4} (0.5 \text{ ft})^2 \left( 60 \frac{\text{sec}}{\text{min}} \right) \left( 3.2808 \frac{\text{ft}}{\text{m}} \right)} = 0.2587 \text{ m/sec}$$

$$\chi_c = 80 \mu\text{g}/\text{m}^3 \text{ (} 0.08 \text{ mg}/\text{m}^3 \text{), for MMH}$$

$$\therefore Q = 1.774 \times 10^{-3} \text{ g/sec MMH (} 3.851 \times 10^{-5} \text{ g moles/sec)}$$

$$10 \text{ cfm} = 0.1962 \text{ g moles/sec total (at } 68^\circ\text{F)}$$



Therefore, the maximum permissible concentration of MMH in the 36 ft. vent stack at KSC, at a vapor vent rate of 10 cfm, is:

$$Y_c = \frac{3.851 \times 10^{-5}}{0.1962} = 1.963 \times 10^{-4} \text{ (or, 196 ppm)}$$

At 400 cfm:

$$V_s = 10.35 \text{ m/sec}$$

$$Q = 7.096 \times 10^{-2} \text{ g/sec (1.540} \times 10^{-3} \text{ g moles/sec)}$$

400 cfm = 7.848 g moles/sec total (at 68°F)

$$Y_c = \frac{1.540 \times 10^{-3}}{7.848} = 1.963 \times 10^{-4} \text{ (or, 196 ppm)}$$

Table 1 gives maximum permissible vent concentrations for various vent dimensions, and various fuels.

Appendix IV  
Refrigeration Calculations

For a refrigeration calculation, the starting material is a single-phase vapor, above the liquid fuel, in equilibrium with the fuel composition. This vapor is withdrawn and passed across a cold coil, where part of the vapor condenses. The relative amount of condensate, and the condensate and vapor compositions, must be solved for by applying material balances and equilibrium relationships. The final vapor composition must satisfy the criteria for maximum allowable effluent concentration, determined by the dispersion calculations of Appendix III.

A material balance can be written for each component:

$$Z_a = X_a f_L + Y_a f_v$$

$$Z_b = X_b f_L + Y_b f_v$$

where  $Z_a, Z_b$  = initial composition of hydrazine (or MMH), and water (respectively) in the fuel vapor

$X_a, X_b$  = composition of hydrazine (or MMH), and water in the condensate

$Y_a, Y_b$  = composition of hydrazine (or MMH), and water in the remaining vapor after refrigeration (determined by dispersion calculations --(see MPVC in Appendix III)

$f_L, f_v$  = fraction of the original fuel vapor which condenses ( $f_L$ ), and remains as a vapor ( $f_v$ ) after refrigeration

By definition:  $X_a + X_b = 1$

$$f_L + f_v = 1$$

(Note:  $Y_a + Y_b \neq 1$ , and  $Z_a + Z_b \neq 1$ , because of the presence of noncondensable gases, such as air or nitrogen.)

There are also 2 equilibrium relationships between Y and X:

$$Y_a = \frac{\gamma_a P_a^\circ X_a}{P}$$

$$Y_b = \frac{\gamma_b P_b^\circ X_b}{P}$$

with terms defined as in Appendix I and II.

These equations can be combined into a single equation which mathematically defines the equilibrium condition after refrigeration of fuel vapors:

$$f(X_a) = \frac{\gamma_b P_b^\circ}{P} [X_a^2 - X_a(1+Z_a) + Z_a] - \frac{\gamma_a P_a^\circ}{P} [X_a^2 - X_a(1-Z_b)] \\ + (Z_a + Z_b)X_a - Z_a = 0$$

This equation may be solved by the Newton-Raphson technique:

$$f'(X_a) = \frac{df(X_a)}{dX_a} = \frac{\gamma_b P_b^\circ}{P} (2X_a - 1 - Z_a) + \frac{P_b^\circ}{P} [X_a^2 - X_a(1+Z_a) + Z_a] \frac{d\gamma_b}{dX_a} \\ - \frac{\gamma_a P_a^\circ}{P} (2X_a - 1 + Z_b) - \frac{P_a^\circ}{P} [X_a^2 - X_a(1-Z_b)] \frac{d\gamma_a}{dX_a} + Z_a + Z_b$$

$$\frac{d\gamma_a}{dX_a} = - \frac{4.6052 A^2 B^2 (1-X_a) \gamma_a}{[AX_a + B(1-X_a)]^3}$$

$$\frac{d\gamma_b}{dX_a} = + \frac{4.6052 A^2 B^2 X_a \gamma_b}{[AX_a + B(1-X_a)]^3}$$

where  $A = - 1.0680$

$B = - 0.5410$

for hydrazine/water

and  $A = - 0.9172$

$B = - 0.3273$

for MMH/water

Solving for  $X_a$  and  $Y_a$  is an iterative procedure:

- (1) Guess refrigeration coil temperature
- (2) Guess  $X_a$ , condensate composition
- (3) Calculate  $f(X_a)$ , and  $f'(X_a)$
- (4) If  $f(X_a) = 0$ , solution for  $X_a$  is reached, go to step (6)
- (5) If  $f(X_a) \neq 0$ ,  $X_a = X_a - [f(X_a)/f'(X_a)]$ .

Go back to step (3) with the new value of  $X_a$ .

- (6) Calculate  $Y_a = \gamma_a P_a^o X_a / P$
- (7) If  $Y_a =$  allowable effluent concentration (see Appendix III) the correct temperature and composition after refrigeration have been arrived at.
- (8) If  $Y_a \neq$  allowable effluent concentration, use method of halving (see below) to find a new temperature, and return to step (2).

#### Method of Halving

This method uses incremental changes in temperature until the temperature interval is found that spans the answer. Then, the interval is halved, and the procedure repeated until the desired accuracy is reached.

Referring to step (8) on previous page, if  $Y_a$  is greater than the allowable vapor concentration, the temperature must be lower, and so is reduced by (e.g.)  $10^\circ\text{F}$ . As long as  $Y_a$  is too large, the temperature continues to be lowered by  $10^\circ\text{F}$ , until  $Y_a$  is too small. Then, go back to the previous temperature (when  $Y_a$  was still too large) and lower the temperature by 5 F. If  $Y_a$  is still too large, reduce the temperature an additional  $2.5^\circ\text{F}$ , and so on, until the desired accuracy is reached.

For Pure Fuels (single component)

When a pure fuel (MMH, hydrazine, or UDMH) is being considered (rather than a mixed fuel like H-70), the above procedure can be greatly simplified, since only one component exists in the condensate. In such cases it is only necessary to find the temperature that will yield the pure component vapor pressure corresponding to the maximum permissible vent concentration (MPVC). That is:

$$Y_a = \frac{P_a^0}{P} = \text{MPVC}$$

$P_a^0$  = function of coil temperature

Table 3 gives the required refrigeration coil temperatures for various fuels.

Appendix V

Incineration Calculations

Assume a fuel such as propane ( $C_3H_8$ ). The following combustion equation can be written:



If the combustion chamber is well insulated, and neglecting the contribution of the hydrazine (or MMH) vapors, a heat balance can be written as follows:

$$3 \bar{Cp}_C (T_f - 25^\circ C) + 4 \bar{Cp}_H (T_f - 25^\circ C) + \left(\frac{E_x}{100}\right) (5) \bar{Cp}_O (T_f - 25^\circ C) + \left(1 - \frac{E_x}{100}\right) \frac{(5)(0.79)}{0.21} \bar{Cp}_N (T_f - 25^\circ C)$$

$$+ \left[ \frac{V_H (60 \text{ min/hr})}{\left(359 \frac{\text{ft}^3}{\text{lb mole}}\right) \left(\frac{T_H}{492}\right)^{M_F}} \right] \bar{Cp}_N (T_f - 25^\circ C) + \Delta H_C^\circ = 0$$

where  $T_f$  = combustion chamber temp. =  $1200^\circ C$  (using max. RCRA criterion<sup>(7)</sup> proposed for halogenated aromatic hydrocarbons)

$\bar{Cp}_C$  = average heat capacity of  $CO_2$  between  $T_f$  and  $25^\circ C$   
=  $51.18 \text{ J/gmole}^\circ C$ <sup>(6)</sup>

$\bar{Cp}_H$  = average heat capacity of  $H_2O$  vapor between  $T_f$  and  $25^\circ C$  =  $39.81 \text{ J/gmole}^\circ C$ <sup>(6)</sup>

$\bar{Cp}_O$  = average heat capacity of  $O_2$  between  $T_f$  and  $25^\circ C$  =  $33.79 \text{ J/gmole}^\circ C$ <sup>(6)</sup>

$\bar{Cp}_N$  = average heat capacity of  $N_2$  between  $T_f$  and  $25^\circ C$  =  $31.88 \text{ J/gmole}^\circ C$ <sup>(6)</sup>

$E_x$  = % excess air = 5% (RCRA recommendation<sup>(7)</sup> is at least 2-3%)

$V_H$  = volumetric flow rate of fuel vapors (= 10 cfm to 400 cfm)

$T_H$  = fuel vapor temperature (in °R)

$\dot{M}_F$  = required mass flow rate of propane (in lb mole/min)

$\Delta H_C^\circ$  = heat of combustion of propane at 25°C  
 = - 2.044 X 10<sup>6</sup> J/gmole (6)

Solving for  $\dot{M}_F$ :

$$\dot{M}_F = 3.324 \frac{V_H}{T_H}$$

when  $V_H = 10$  cfm,  $T_H = 528$  °R (68°F)

$$\dot{M}_F = 0.063 \text{ lb moles/hr (22.6 ft}^3\text{/hr at STP)}$$

when  $V_H = 400$  cfm,  $T_H = 528$  °R (68°F)

$$\dot{M}_F = 2.52 \text{ lb moles/hr (904 ft}^3\text{/hr at STP)}$$

Knowing the fuel rate, the volumetric flow of combustion gases ( $V_C$ ) can be calculated:

$$V_C = \left[ 3 + 4 + \left(\frac{E_X}{100}\right)5 + \left(1 + \frac{E_X}{100}\right) \frac{5(0.79)}{0.21} + \frac{V_H (60 \text{ Min/hr})}{\left(359 \frac{\text{ft}^3}{\text{lb mole}}\right) \left(\frac{T_H}{492}\right) \dot{M}_F} \right] \dot{M}_F \left(359 \frac{\text{ft}^3}{\text{lb mole}}\right) \left(\frac{1473^\circ\text{K}}{273^\circ\text{K}}\right)$$

$$V_C = \left(27 + \frac{82.23V_H}{T_H \dot{M}_F}\right) 1937 \dot{M}_F$$

But  $\frac{V_H}{T_H \dot{M}_F} = \frac{1}{3.324}$

$$V_C = 1.00 \times 10^5 \dot{M}_F$$

when  $V_H = 10$  cfm,  $T_H = 528^\circ\text{R}$ ,  $\dot{M}_F = 0.063$  lb mole/hr

$$V_C = 6310 \text{ ft}^3/\text{hr at } 1200^\circ\text{C}$$

For a residence time of 2 seconds (following RCFA recommendations<sup>(7)</sup>):

$$\text{combustion chamber volume} = \left( \frac{V_C}{3600 \text{ sec/hr}} \right) (2 \text{ seconds}) = 3.50 \text{ ft}^3$$

At 400 cfm fuel vapor flow:

$$V_C = 2.52 \times 10^5 \text{ ft}^3/\text{hr, at } 1200^\circ\text{C for a combustion chamber volume of } 140 \text{ ft}^3; \text{ or a 4 ft diameter X 12 ft long incinerator}$$

With natural gas (methane) as the fuel:

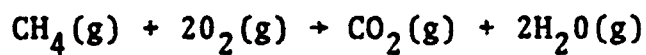

$$\Delta H_C^\circ = - 8.023 \times 10^5 \text{ J/gmole}^{(6)}$$

Using the same procedure as before:

$$\dot{M}_F = 8.832 \frac{V_H}{T_H}$$

when  $V_H = 10$  cfm,  $T_H = 528^\circ\text{R}$  ( $68^\circ\text{F}$ )

$$\dot{M}_F = 0.167 \text{ lbmoles/hr (60 ft}^3/\text{hr at STP)}$$

$$V_C = 3.934 \times 10^4 \dot{M}_F = 6580 \text{ ft}^3/\text{hr, at } 1200^\circ\text{C; for a combustion chamber volume of } 3.65 \text{ ft}^3.$$

when  $V_H = 400$  cfm,  $T_H = 528^\circ\text{R}$  ( $68^\circ\text{F}$ )

$$\dot{M}_F = 6.69 \text{ lb moles/hr (2400 ft}^3/\text{hr at STP)}$$

$$V_C = 3.934 \times 10^4 \dot{M}_F = 2.63 \times 10^5 \text{ ft}^3/\text{hr at } 1200^\circ\text{C, for a combustion chamber volume of } 146 \text{ ft}^3; \text{ or again, a 4 ft diameter X 12 ft long incinerator}$$



With isopropanol at the fuel:

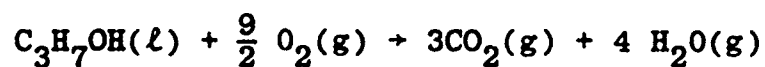

$$\Delta H_c^\circ = -1.811 \times 10^6 \text{ J/gmole}^{(6)}$$

Using the same calculation procedure as before:

$$\dot{M}_F = 4.009 \frac{V_H}{T_H}$$

when  $V_H = 10 \text{ cfm}$ ,  $T_H = 528^\circ\text{R}(68^\circ\text{F})$

$$\dot{M}_F = .076 \text{ lb moles/hr (0.012 gpm)}$$

$$V_C = 0.8816 \times 10^5 \dot{M}_F = 6690 \text{ ft}^3/\text{hr}, \text{ for a combustion chamber volume of } 3.72 \text{ ft}^3.$$

when  $V_H = 400 \text{ cfm}$ ,  $T_H = 528^\circ\text{R}(68^\circ\text{F})$

$$\dot{M}_F = 3.037 \text{ lb moles/hr (0.464 gpm)}$$

$$V_C = 2.68 \times 10^5 \text{ ft}^3/\text{hr}, \text{ for a combustion chamber volume of } 149 \text{ ft}^3; \text{ or again, a 4 ft diameter X 12 ft long incinerator.}$$

Appendix VI  
Scrubber Calculations

The outlet vapor concentration from the scrubber must satisfy the criteria for maximum allowable effluent concentration, determined by the dispersion calculations of Appendix III.

Once the outlet vapor concentration is known, a material balance will yield the outlet liquid concentration and liquor flow rate.

For example, with the 36 ft vent line at KSC, the outlet concentration ( $Y_{\text{cout}}$ ) must be 196 ppm MMH or less. Based on an MMH fuel temperature of 68°F, the inlet concentration to the scrubber is determined as follows:

at 68°F,  $P_c^\circ = 37.35$  mmHg (see Appendix II)

$$Y_{\text{cin}} = \frac{\gamma_c P_c^\circ X_c}{P}$$

since the fuel is pure MMH:

$$X_c = 1.0$$

$$\gamma_c = 1.0$$

and  $Y_{\text{cin}} = 0.04914$  (at  $P = 760$  mmHg)

assuming water is used as the scrubbing medium:

$$X_{\text{cin}} = 0$$

and by an MMH balance around the scrubber:

$$V'(Y_{\text{cin}} - Y_{\text{cout}}) = L'(X_{\text{cout}} - X_{\text{cin}})$$

the fuel vapor rate ( $V'$ ) is known for various cases, but both the liquid rate ( $L'$ ) and outlet liquor composition ( $X_{\text{cout}}$ ) are unknown.

However, let's assume a single equilibrium contact stage for the scrubber. At equilibrium:

$$Y_{\text{cout}} = \frac{\gamma_c P_c^{\circ} X_{\text{cout}}}{P}$$

For an isothermal scrubber, at 68°F (see Appendix II):

$$P_c^{\circ} = 37.35 \text{ mmHg}$$

$$\log_{10} \gamma_c = \frac{-0.9172}{\left[1 + \frac{0.9172 X_c}{0.3273(1-X_c)}\right]^2}$$

$$\text{and } P = 760 \text{ mmHg}$$

The resulting equation must then be solved for  $X_{\text{cout}}$  by a trial-and-error procedure. Using the Newton-Raphson method:

$$f(X_{\text{cout}}) = Y_{\text{cout}} - \frac{\gamma_c P_c^{\circ} X_{\text{cout}}}{P} = 0$$

$$f'(X_{\text{cout}}) = \frac{dF(X_{\text{cout}})}{dX_{\text{cout}}} = -\frac{\gamma_c P_c^{\circ}}{P} - \left(\frac{P_c^{\circ} X_{\text{cout}}}{P}\right) \frac{d\gamma_c}{dX_{\text{cout}}}$$

$$\frac{d\gamma_c}{dX_{\text{cout}}} = \frac{4.6052 A^2 B^2 (1-X_{\text{cout}}) \gamma_c}{[A X_{\text{cout}} + B(1-X_{\text{cout}})]^3}, \quad \begin{array}{l} A = -0.9172 \\ B = -0.3273 \\ \text{(see Appendix IV)} \end{array}$$

- (1) Guess  $X_{\text{cout}}$
- (2) Calculate  $f(X_{\text{cout}})$ . If it's zero, you have the right value of  $X_{\text{cout}}$ .
- (3) If  $f(X_{\text{cout}}) \neq 0$ , calculate  $f'(X_{\text{cout}})$ .
- (4)  $X_{\text{cout}} = X_{\text{cout}} - (f/f')$
- (5) Go back to step (2)

Continuing the same example of MMH stored at 68°F, the above method yields the solution:

$$X_{\text{cout}} = 0.02510$$

This waste liquor can be treated separately with sodium hypochlorite, to destroy the MMH.

Now, the material balance can be used to find the scrubber water rate (L'):

$$V'(Y_{\text{cin}} - Y_{\text{cout}}) = L'(X_{\text{cout}} - X_{\text{cin}})$$

For the present example, with 10 cfm of fuel vapor:

$$L' = \left(\frac{10 \text{ ft}^3}{\text{MIN}}\right) \left(\frac{\text{lb mole}}{359 \text{ ft}^3}\right) \left(\frac{492^\circ\text{R}}{528^\circ\text{R}}\right) \left(\frac{0.04914 - 196 \times 10^{-6}}{0.02510 - 0}\right) = 0.0506 \frac{\text{lb moles}}{\text{min}}$$

or  $L' = 0.11 \text{ gpm water}$

At 400 cfm fuel vapor flow:

$$L' = 4.4 \text{ gpm water}$$

This establishes the minimum water requirement for the system. As a first approximation to the actual design, let the water flow rate be twice minimum, or 8.8 gpm at 400 cfm of fuel vapor.

In order to continue the scrubber calculations, the design of a counter-current packed column must now be considered (see Figure A-1).

The following parameters govern counter-current packed column design<sup>(8)</sup>:

$$\alpha = \frac{L}{G} \sqrt{\frac{\rho_g}{\rho_l}}$$

$$\beta = \frac{G^2 F v^{0.1}}{\rho_g (\rho_l - \rho_g)}$$

where  $L$  = liquid flow rate ( $\text{lbm}/\text{ft}^2 \cdot \text{sec}$ )

$G$  = gas flow rate ( $\text{lbm}/\text{ft}^2 \cdot \text{sec}$ )

( $\text{ft}^2$  meant "per  $\text{ft}^2$  of column cross-section")

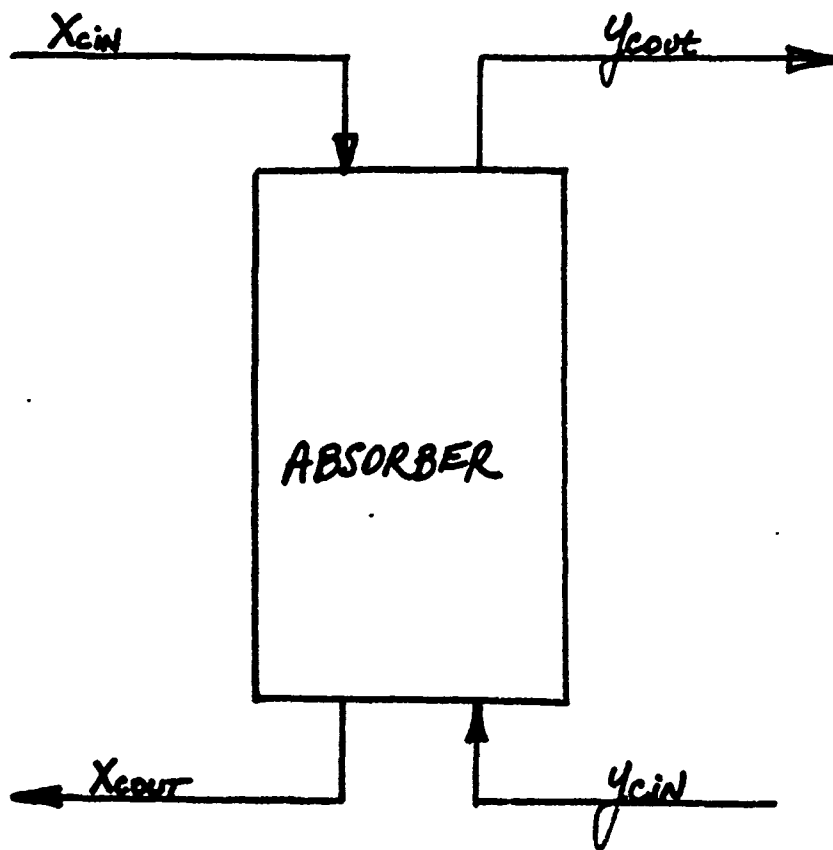
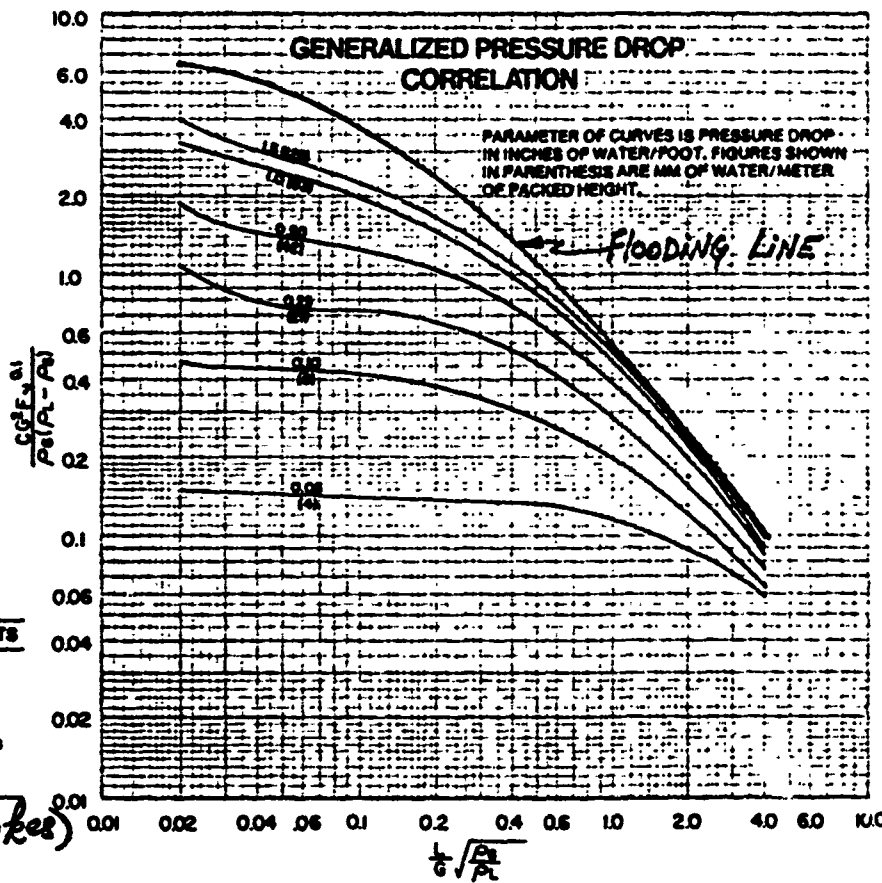

FIGURE A-1 - COUNTER-CURRENT  
ABSORBER

**FIGURE A-2<sup>(8)</sup>**

# Design Techniques for Sizing Packed Towers



GENERALIZED PRESSURE DROP CORRELATION			
PROPERTY	SYMBOL	BRITISH UNITS	METRIC UNITS
Gas Rate	G	Lbs/ft <sup>2</sup> sec	KG/M <sup>2</sup> s
Liquid Rate	L	Lbs/ft <sup>2</sup> sec	KG/M <sup>2</sup> s
Gas Density	$\rho_g$	Lbs/ft <sup>3</sup>	KG/M <sup>3</sup>
Liquid Density	$\rho_L$	Lbs/ft <sup>3</sup>	KG/M <sup>3</sup>
Liquid Viscosity	$\nu$	Centistokes	Centistokes
Conversion Factor	C	1.000	10.784
Packing Factor	F	—	—

*Kiwey*

$\nu = \mu/\rho$  in  $\frac{CP}{(g/cc)}$  (centistokes)

## Packing Factors (F) (DUMPED PACKING)

Packing Type	Mat'l.	Nominal Packing Size (Inches)										
		1/4	3/8	1/2	5/8	3/4	1 or #1	1 1/4	1 1/2	2 or #2	3	3 1/2 or #3
Hy-Pak™	Metal						43			18		15
Super Intalox® Saddles	Ceramic						60			30		
Super Intalox Saddles	Plastic						33			21		16
Pall Rings	Plastic				97		52		40	24		16
Pall Rings	Metal				70		48		33	20		16
Intalox® Saddles	Ceramic	725	330	200		145	92		52	40	22	
Raschig Rings	Ceramic	1600	1000	580	380	255	155	125	95	65	37	
Raschig Rings	1/2" metal	700	390	300	170	155	115					
Raschig Rings	1/4" metal			410	290	220	137	110	83	57	32	
Berl Saddles*	Ceramic	900		240		170	110		65	45		

Packing factors determined with an air-water system in 30" I.D. tower.  
\*Data by Leve

$\rho_g$  = vapor density (lbm/ft<sup>3</sup>)

$\rho_l$  = liquid density (lbm/ft<sup>3</sup>)

$\nu$  = kinematic viscosity of the liquid  
 =  $\mu/\rho$  (centistokes, cp/g/cc)

F = packing factor (dimensionless)

For proper column operation,  $\alpha$  must lie between 0.02 and 4.0. Below .02, the gas velocity is so much higher than the liquid velocity that entrainment of liquid into the gas stream becomes a problem, and there is also a danger of drying out the packing at various locations within the column (this means loss of effective mass transfer surface). Above 4.0, the gas pressure drop through the column becomes excessive, and the column gradually floods with liquid (which becomes the continuous phase), as gas just bubbles through the bed (again, resulting in a loss of mass transfer surface).

Furthermore, values of  $\beta$  are constrained by the column pressure drop - if  $\beta$  is too high, the pressure drop will be excessive; and if  $\beta$  is too low ( $\ll .05$  inches of water/ft of packing) a good gas flow distribution will be difficult to achieve.  $\beta$  is a function of the square of the gas flow.

Good distribution of liquid and gas throughout the column is the key to packed column performance, and therefore, the design of distribution grids can be critical.

Figure A-2 shows the generalized pressure drop correlation for packed columns<sup>(8)</sup>. However, calculation of the packed height requires a knowledge of the mass transfer coefficient, and mass transfer coefficients for hydrazine fuels and water are at present unknown.

Therefore, as an approximation, the mass transfer coefficient ( $K_G a$ ) for the ammonia-water system was used:

for 1-1/2" ceramic Intalox Saddles<sup>(9)</sup>,

$$K_G a \text{ (ammonia-water)} = \frac{13.0 \text{ lbmoles}}{\text{hr} \cdot \text{atm} \cdot \text{ft}^3 \text{ of packing}}$$

$$\text{Ratio } \frac{K_G a \text{ (1")}}{K_G a \text{ (1\frac{1}{2}")}} \text{ (for CO}_2 \text{ - NaOH)}^{(8)} = \frac{3.0}{2.3} = 1.30$$

(these mass transfer coefficients were developed for  $L = 5000 \text{ lbm/ft}^2 \text{ hr}$ , and  $G = 500 \text{ lbm/ft}^2 \text{ hr}$ ).

The mass transfer coefficient also varies with liquid flow rate: for 1" ceramic Intalox Saddles ( $\text{CO}_2\text{-NaOH}$  system)<sup>(8)</sup>,  $K_G a$  varies as  $L^{0.344}$  (for  $L$  in  $\text{lbm/hr. ft}^2$ ). At 8.8 gpm,  $L = \frac{4398}{A} \text{ lbm/hr. ft}^2$  (where  $A = \text{column cross-section in ft}^2$ ).

$$\frac{K_G a \text{ (4398/A lbm/hr. ft}^2\text{)}}{K_G a \text{ (5000 lbm/hr. ft}^2\text{)}} = \left(\frac{4398}{5000A}\right)^{0.344} = \frac{0.9568}{A^{0.344}}$$

$K_G a$  also increases with increasing gas flow rate, although the effect is not as significant as with increasing liquid flow. Since systematic data showing the variation of  $K_G a$  with gas flow rate were not available, this effect was ignored, which tends to make the packed column design more conservative (i.e. taller than it has to be).

Considering these factors:

$$K_G a \text{ (1" ceramic Intalox Saddles, ammonia-water, 8.8 gpm water flow rate)} = 13.0 (1.30) \frac{(0.9568)}{A^{0.344}} = \frac{16.17}{A^{0.344}} \frac{\text{lb moles}}{\text{hr} \cdot \text{atm} \cdot \text{ft}^3 \text{ packing}}$$

From the definition of the mass transfer coefficient:

$$K_G a = \frac{N}{H A P \Delta Y_{1m}}$$



$$\Delta Y_{lm} = \frac{(Y_{cin} - Y_{cin}^*) - (Y_{cout} - Y_{cout}^*)}{\ln(Y_{cin} - Y_{cin}^*) - \ln(Y_{cout} - Y_{cout}^*)}$$

where:  $N$  = lbmoles transferred/hr

$H$  = packed height (ft)

$A$  = column cross-section (ft<sup>2</sup>)

$P$  = total system pressure (atm)

$Y$  = actual gas phase mole fraction

$Y^*$  = gas phase mole fraction if it were in equilibrium with the adjacent liquid

In the continuing example of 400 cfm MMH vapors at 68°F, scrubbed with 8.8 gpm water:

$$P = 1 \text{ atm}$$

$$N = V' (Y_{cin} - Y_{cout}) = 3.049 \text{ lbmoles/hr}$$

$$Y_{cout} = 196 \times 10^{-6}$$

$$Y_{cin} = 0.04914$$

$$Y_{cout}^* = \frac{\gamma_c P_c^o X_{cin}}{P} = 0$$

$$Y_{cin}^* = \frac{\gamma_c P_c^o X_{cout}}{P} = 8.608 \times 10^{-5} \text{ (for } X_{cout} = 0.01255)$$

$$\Delta Y_{lm} = 8.847 \times 10^{-3}$$

$$H = \frac{21.31}{A^{0.656}} \text{ ft}$$

Under these conditions:

$$\rho_l = 62.3 \text{ lbm/ft}^3$$

$$\rho_g = 0.0726 \text{ lbm/ft}^3 \text{ (based on nitrogen)}$$

$$v = 1.0$$

$$F = 92$$

$$\alpha = 0.0862$$

$$\beta = \frac{4.765}{A^2}$$

In addition, to avoid excessive fluid channeling, the packed height must be no more than 8 column diameters<sup>(8)</sup>. Therefore,

$$H_{\max} = 8D = 8\sqrt{\frac{4A}{\pi}}$$

These various constraints can be summarized as follows:

$$H_{\text{total}} = \frac{21.31}{A^{0.656}} \text{ ft}$$

$$H_{\max}/\text{column} = 9.027A^{0.5} \text{ ft}$$

$$\beta = \frac{4.765}{A^2}$$

$$\alpha = 0.086$$

For this value of  $\alpha$ , a practical limit on  $\beta$  is about 2.3. Substituting for  $\beta$  into the above formula gives a cross-sectional area (A) of 1.44 ft<sup>2</sup>, or a column diameter of 16.2 inches. However, standard size columns would probably be 15 inches or 18 inches in diameter.

At 18 inches:

$$A = 1.767 \text{ ft}^2$$

$$\beta = 1.526 \text{ } (\Delta p \sim 0.65 \text{ in } H_2O/\text{ft packing})$$

$$H_{\text{total}} = 14.67 \text{ ft}$$

$$H_{\max}/\text{column} = 12.0 \text{ ft}$$

Therefore, two columns in series are needed, each 18" diam. X 8.8 ft high (with a 20% safety factor), packed with 1" ceramic Intalox Saddles (total pressure drop is 11.4 in. H<sub>2</sub>O at 400 cfm).

As the gas flow through the column drops,  $\beta$  drops as the square of gas flow. At 72 cfm of fuel vapor,  $\alpha=0.48$ , and  $\beta=0.05$  ( $\Delta P < .05$  inches H<sub>2</sub>O/ft packed height). This is approximately the limit of operability of this scrubber. Another set of parallel columns must therefore be sized to handle gas flows below 72 cfm.

For 72 cfm fuel vapor, and 1.6 gpm water:

$$\alpha = .087$$

$$\beta = \frac{0.3356}{A^2} \text{ (with } \frac{1}{2} \text{'' ceramic Intalox saddles)}$$

$$K_G a = \frac{14.55}{A^{0.3}} \text{ lbmoles/hr} \cdot \text{atm} \cdot \text{ft}^3 \text{ (with } \frac{1}{2} \text{'' ceramic Intalox saddles)}$$

$$N = 0.5488 \text{ lbmoles/hr}$$

$$Y_{\text{cout}} = 196 \times 10^{-6}$$

$$Y_{\text{cin}} = 0.04914 \text{ (at } 68^\circ\text{F)}$$

$$Y_{\text{cout}}^* = \frac{\gamma_c P_c^\circ X_{\text{cin}}}{P} = 0$$

$$Y_{\text{cin}}^* = \frac{\gamma_c P_c^\circ X_{\text{cout}}}{P} = 8.47 \times 10^{-5} \text{ (for } X_{\text{cout}} = 0.01237)$$

$$\Delta Y_{\text{lm}} = 8.847 \times 10^{-3}$$

$$H = \frac{4.264}{A^{0.7}} \text{ ft}$$

Again, for  $\beta_{\text{max}} = 2.3$ ,  $A = 0.3820 \text{ ft}^2$  ( $D = 0.697 \text{ ft} \approx 8.4 \text{ inches}$ )

Let  $D = 8 \text{ inches}$  (standard pipe size)

$$A = 0.3491 \text{ ft}^2$$

$$\beta_{\text{max}} = 2.75 \text{ } (\Delta p \sim 2 \text{ in. H}_2\text{O/ft packing)}$$

For  $\beta_{\text{min}} = 0.05$

$$V_{\text{min}} = 9.7 \text{ cfm } (\alpha = 0.65)$$

Therefore, this set of columns can be used effectively down to the 10 cfm limit.

For an 8" column:

$$H_{\text{total}} = 8.91 \text{ ft.}$$

$$H_{\text{max/column}} = 5.3 \text{ ft}$$

Therefore, two more columns in parallel are needed, 8 inches diameter X 5.3 ft high (with 20% safety factor), packed with  $\frac{1}{2}$ " ceramic Intalox Saddles (total pressure drop is 21.2 in.  $H_2O$  at 72 cfm).

Total Scrubber Package:

- 4 columns
- 2 in series, to handle vapor flows from 72 to 400 cfm, each 18 in. diameter x 8.8 ft high, packed with 1" ceramic Intalox Saddles. Water flow rate is 8.8 gpm.
- 2 more acting as a parallel set of series columns, to handle vapor flows from 10 to 72 cfm, each 8 in. diameter x 5.3 ft high, packed with  $\frac{1}{2}$ " ceramic Intalox Saddles. Water flow rate is 1.6 gpm.

Assumes MMH @ 68°F (49,140 ppm in - 196 ppm out).

These same scrubbers could also be used to handle hydrazine and H-70 vapors, at temperature from 43°F in order to avoid freeze-ups) to 100°F, by simply adjusting the water flow rates (see Table 2).

Present KSC Fuel Scrubber Design

At the present time, 2 series scrubbers are located near the Hypergolic Maintenance Facility. Each has an inside diameter of 30 inches, and is packed to a height of 4 ft with  $\frac{3}{4}$ " Intalox Saddles.

For 400 cfm of fuel vapor, 95 gpm water flow, at 68°F:

$$L = 2.687 \text{ lbm/ft}^2 \text{ sec}$$

$$G = 0.0986 \text{ lbm/ft}^2 \text{ sec}$$

$$\rho_L = 62.3 \text{ lbm/ft}^3$$

$$\rho_G = 0.0726 \text{ lbm/ft}^3$$

$$A = 4.91 \text{ ft}^2$$

$$F = 145$$

$$\alpha = 0.93$$

$$\beta = 0.312 (\Delta p = 0.25 \text{ in. } H_2O/\text{ft packing})$$

$$K_G a = 22.7 \text{ lbmoles/hr} \cdot \text{atm} \cdot \text{ft}^3 \text{ of packing}$$

$$H_{\text{total}} = 8 \text{ ft.}$$

$$N = V' (Y_{\text{cin}} - Y_{\text{cout}})$$

$$P = 1 \text{ atm}$$

$$K_G a = \frac{N}{HAP \Delta Y_{\text{lm}}}$$

$$22.7 = \frac{62.20(0.04914 - Y_{\text{cout}})}{(8)(4.91)(1) \Delta Y_{\text{lm}}}$$

$$\Delta Y_{\text{lm}} = \frac{(Y_{\text{cin}} - Y_{\text{cin}}^*) - (Y_{\text{cout}} - Y_{\text{cout}}^*)}{\ln(Y_{\text{cin}} - Y_{\text{cin}}^*) - \ln(Y_{\text{cout}} - Y_{\text{cout}}^*)}$$

$$Y_{\text{cin}} = 0.04914$$

$$X_{\text{cin}} = 0$$

$$Y_{\text{cout}}^* = \frac{\gamma_c P_c X_{\text{cin}}}{P} = 0$$

$$X_{\text{cout}} = \frac{V'(Y_{\text{cin}} - Y_{\text{cout}})}{L'} = 0.02364(.04914 - Y_{\text{cout}})$$

$$Y_{\text{cin}}^* = \frac{\gamma_c P_c X_{\text{cout}}}{P} = .00116(.04914 - Y_{\text{cout}}) \gamma_c$$

Solving by trial-and-error:

$$Y_{\text{cout}} = 3.0 \times 10^{-8} \text{ (or, .03 ppm)}$$

$$(X_{\text{cout}} = 1.16 \times 10^{-3})$$

Below 93 cfm,  $\alpha$  is greater than 4.0, and the column will flood (as described above). Furthermore, below about 160 cfm, the column pressure drop will be so low that good gas distribution will be difficult to achieve. Therefore, column efficiency would be expected to fall off at fuel vapor rates below 100-150 cfm. Results of Martin-Marietta<sup>(11)</sup> are mixed with regard to a decrease in the fuel vapor rate. With 14% citric acid as the scrubbing liquor, the

efficiency does indeed decline below about 150 cfm. However, with 5% NaOCl as the scrubbing liquor, the opposite results were obtained (the efficiency declines above 150 cfm).